



Product manual

# Constant volume dampers

RKP-P

Airflow regulation

Version 1.0.6  
Date: 09.12.2024.

# RKP-P

- For maintaining constant air volume in ventilation systems, without additional power supply
- Made of galvanized steel sheet, damper blade made of anodized aluminium sheet
- Recommended airflow velocity from 3 to 8 m/s, at pressure difference  $\Delta p > 50$  Pa
- Adjusting required constant amount is done by turning of working screw on the right side of the cover
- Working temperature  $-20...80^{\circ}\text{C}$
- Relative humidity  $5...80\%$  rh
- Constant flow  $\pm 10\%$  set value
- Casing airtightness Class C
- Casing insulation 32 mm, more information on [link!](#)



- ▼ [Product overview](#)
- ▼ [Actuators](#)
- ▼ [Ordering key](#)
- ▼ [Installation](#)
- ▼ [Maintenance](#)



[Product calculation software](#)



## PRODUCT OVERVIEW

## AIRFLOW REGULATION

### DIMENSIONS

Size BxH [mm]	200x100	200x150	200x200	300x100	300x150	300x200	300x250	300x300	400x200	400x250	400x300	500x200	500x250	500x300	600x200	600x250	600x300
L [mm]	350	350	350	350	350	350	350	350	350	350	350	350	350	350	350	350	350
Pressure drop [Pa]	732,8	844,5	956,2	694,3	794,5	758,5	780,8	803,1	825,3	833	766,5	933,1	797	863,8	542,9	663,5	835,6
Vmin [m³/h]	200	250	350	250	350	500	600	750	700	800	1000	875	1000	1200	1125	1400	1600
Vmax [m³/h]	800	1200	1550	1200	1650	2100	2800	3500	3300	3700	4250	4125	4375	5200	4750	6000	7000
mass RKP-P [kg]	3,5	4,4	5,3	5,4	5,9	6,4	6,9	7,4	7,5	8,0	8,7	8,7	9,2	9,8	9,7	10,4	11
mass RKP-P-Z [kg]	5,8	6,55	7,3	7,4	8,1	8,8	9,5	10,2	10,5	11,2	12	12	12,8	13,6	13,6	14,4	15,3

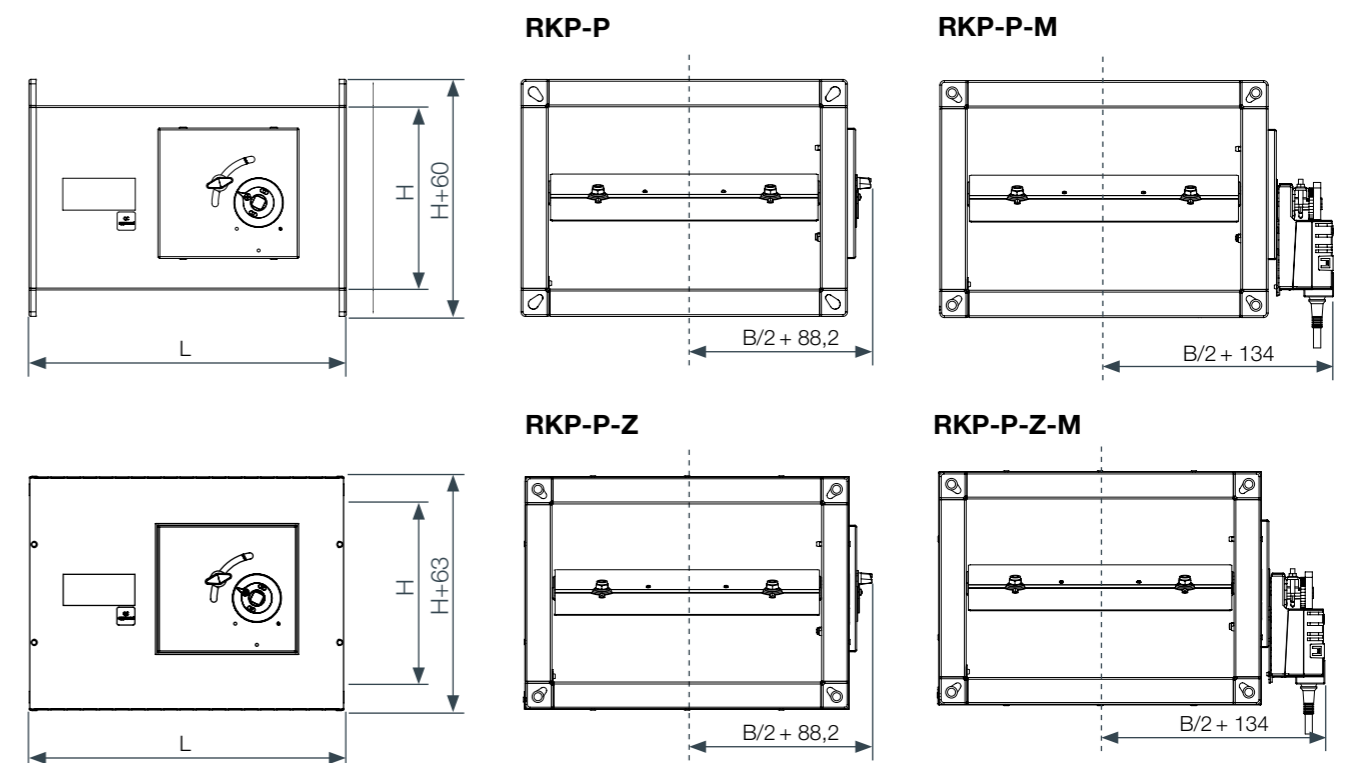



- ▼ [Product overview](#)
- ▼ [Actuators](#)
- ▼ [Ordering key](#)
- ▼ [Installation](#)
- ▼ [Maintenance](#)

## Belimo motor drive

- motor drives - Belimo (open/close, continuous)
- power supply - AC 230V  
- DC 24V
- IP54 degree of protection

Voltage AC/DC	Type	Control	Torque	Energy consumption	Wire sizing	Weight [kg] approx.	Dimension (F x E)
DC24V	LM24A	3-point	5 Nm	1 W	1.5 VA	0.46	160 x 90
	LM24A-SR	continuous	5 Nm	1 W	2VA	0.40	160 x 90
AC 230V	LM230A	3-point	5 Nm	1,5 W	3,5 VA	0.46	160 x 90
	LM230A-SR	continuous	5 Nm	2 W	4 VA	0.50	180 x 90

 ACTUATORS

## Wiring diagram

### OZ -open/close

AC/DC 24 V, open/close

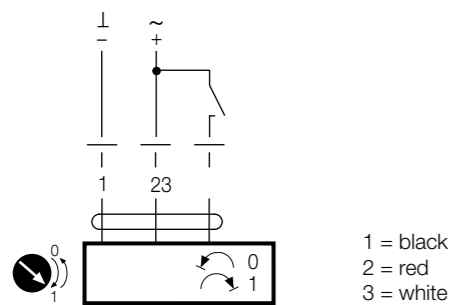

AC/DC 24 V, 3-point

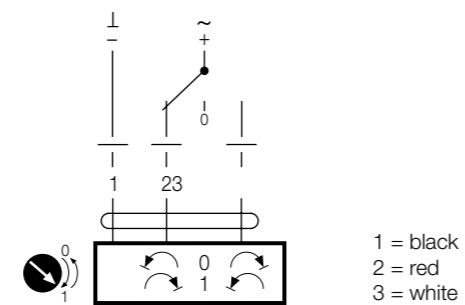

### K -continuous

AC/DC 24 V, modulating

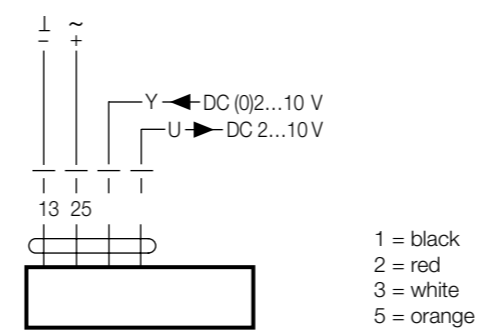



- ▼ [Product overview](#)
- ▼ [Actuators](#)
- ▼ [Ordering key](#)
- ▼ [Installation](#)
- ▼ [Maintenance](#)



ORDERING KEY

AIRFLOW REGULATION

**ORDERING KEY  
RKP-P**

(1) Constant volume damper      (2) Dimensions      (3) Drive      (4) Insulation

**RKP-P - BxH - R - Z**

- (1) **RKP-P**
- (2) Dimensions **BxH**
- (3) **R** - manual drive  
**M24-K** - motor drive - continuous regulation  
**M24-OZ** - motor drive - two-position regulation  
**M230-K** - motor drive - continuous regulation  
**M230-OZ** - motor drive - two-position regulation
- (4) **Z** - insulation

**ORDERING KEY  
ACCESSORIES**

(1) Accessories      (2) Type      (3) Length

**FD-A - CF60 - 200**

- (1) **FD-A**
- (2) Type  
**CF60** - Connecting frame 60 mm
- (3) Connecting frame length  
**200 ... 600** [mm]

**ORDERING KEY  
MANUAL TO  
ELECTRIC DRIVE**

(1) Upgrade Kit

**RKP-A-M-KIT**

- (1) **RKP-A-M-KIT**  
Kit upgrade from manual to electric drive

# Installation process

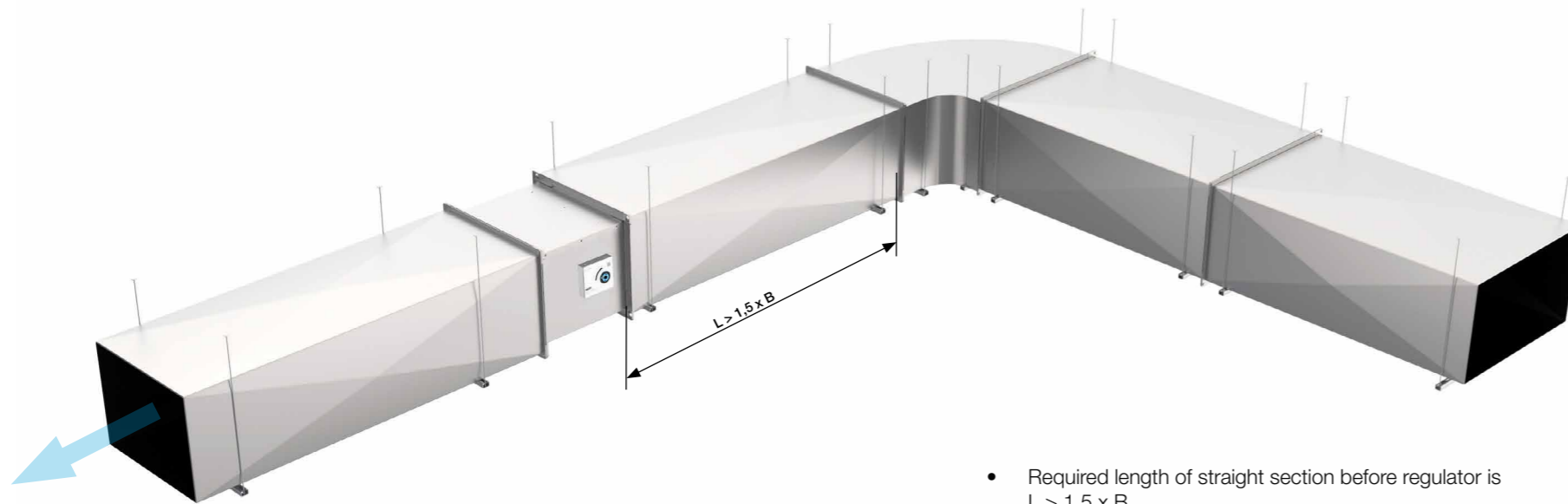

- Required length of straight section before regulator is  $L > 1,5 \times B$  .
- If  $L < 1,5 \times B$ , a 10% error in regulation occurs so that kind of installation is not advisable
- Pay attention to airflow direction marking on the regulator. If not correctly installed, regulator will not work
- Maintenance is not required

- ▼ [Product overview](#)
- ▼ [Actuators](#)
- ▼ [Ordering key](#)
- ▼ [Installation](#)
- ▼ [Maintenance](#)

## INSTALLATION

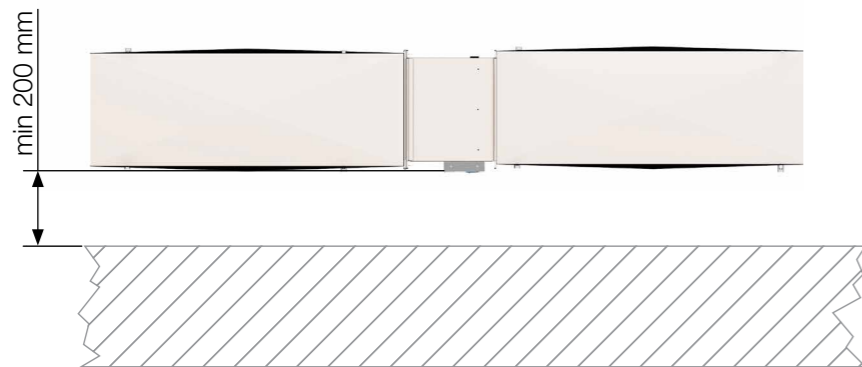



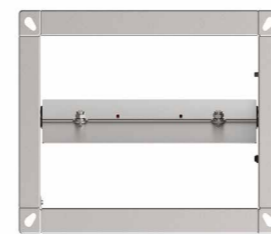
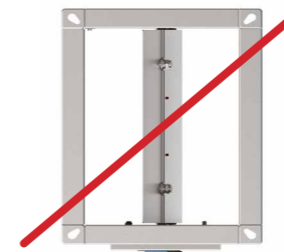

Installation in horizontal, angled or vertical duct so that rotation axis is always in horizontal position.



# RKP-P Battery assembly installation 1x2



-  [Product overview](#)
-  [Actuators](#)
-  [Ordering key](#)
-  [Installation](#)
-  [Maintenance](#)



[Product calculation software](#)



PRODUCT OVERVIEW

AIRFLOW REGULATION

1. Fix the dampers to the duct.
2. Place the installation kit (CF 60) to the dampers.
3. Attach the installation kit to the dampers using the selftapping screws every 100 mm.



## Upgrade from manual to electric drive



1. Install RKP-C on the duct



2. Unscrew the handle and set the indicator on the black horizontal mark



3. Pierce the product sticker on the X marks and install motor mount with three self-tapping screws; 3,9x13 DIN 7981.



4. Install the motor shaft with two self-tapping screws 3,9x13 DIN 7981. (1,5 Nm)



5. Lock lower part of the actuator on the motor mount and upper part on the motor shaft. The lateral side of actuator should be parallel with the lateral side of mechanism cover



6. Press and hold the black button on the actuator



7. While holding the button, rotate the jaw counter-clockwise to the limiter



8. Check that the indicator is in horizontal position, release the button and tighten the screws simultaneously



9. Unscrew the handle, press and hold the black button and set the indicator on the wanted minimal air flow value. In this case we will set it to the 1200 m<sup>3</sup>/h. Release the button and tighten the handle again



10. Unscrew the screw on the left limiter; push and tighten it under the jaw



11. Unscrew the handle, press and hold the black button and set the indicator on the wanted maximum air flow value. In this case we will set it to the 2600 m<sup>3</sup>/h. Release the button and tighten the handle again

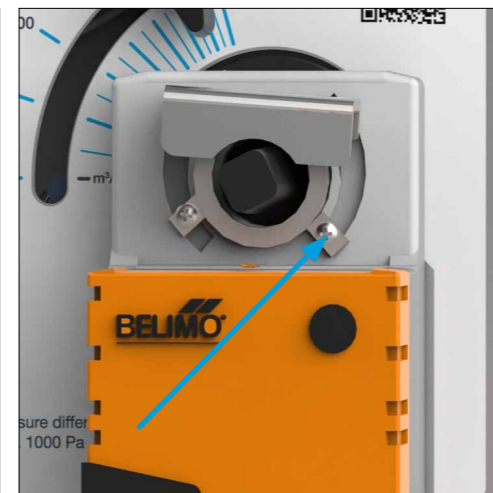

12. Unscrew the screw on the right limiter; push and tighten it under the jaw



13. Unscrew the handle, press and hold the button, rotate the jaw together with shaft to the previously minimum set value and remove the handle at the end

- ▶ [Product overview](#)
- ▶ [Actuators](#)
- ▶ [Ordering key](#)
- ▶ [Installation](#)
- ▶ [Maintenance](#)

## INSTALLATION



[Video instructions](#)

## Installation process

### Air flow/ Voltage

#### Control signal voltages for RKP-P with continuous motor regulation

V[m³/h]	200 x 100	200 x 150	200 x 200	300 x 100	300 x 150	300 x 200	300 x 250	300 x 300	400 x 200	400 x 250	400 x 300	500 x 200	500 x 250	500 x 300	600 x 200	600 x 250	600 x 300
300	3,1	2,3															
400	4,5	3,7	3,0	3,5													
500	5,9	4,9	3,9	4,7	3,3												
600	7,3	5,9	4,6	5,8	4,2	2,9											
700	8,7	6,7	5,4	6,9	5,0	3,6											
800		7,5	6,1	7,7	5,8	4,3	2,9		2,8								
1000			7,3		7,1	5,4	4,1	3,1	3,7	3,1							
1200			8,2		8,1	6,5	5,0	4,0	4,6	4,0	3,0	2,9					
1400						7,4	5,8	4,8	5,3	4,7	3,8	3,5	3,2	3,3	3,1		
1600						8,2	6,4	5,5	6,0	5,3	4,5	4,2	3,9	3,9	3,6	3,2	
1800							7,0	6,1	6,7	5,9	5,1	4,8	4,4	4,3	4,1	3,7	
2000							7,5	6,7	7,2	6,4	5,6	5,3	4,9	4,8	4,6	4,2	4,0
2500							8,7	7,8	8,4	7,6	6,7	6,4	6,0	5,7	5,5	5,2	5,0
3000								8,8		8,8	7,7	7,4	7,0	6,5	6,3	5,9	5,8
3500										8,8	8,5	7,9	7,1	7,1	6,7	6,6	
4000												8,8	7,7	7,5	7,1	7,0	
4500													8,3	8,2	7,5	7,6	
5000														8,7	8,2	8,0	
5500															8,7	8,6	
6000																	9,0

- [Product overview](#)
- [Actuators](#)
- [Ordering key](#)
- [Installation](#)
- [Maintenance](#)

## INSTALLATION





- ▼ [Product overview](#)
- ▼ [Actuators](#)
- ▼ [Ordering key](#)
- ▼ [Installation](#)
- ▼ [Maintenance](#)



## TRANSPORT

After arrival, check the damper for transport damage and shortcomings. In case of any damage or shortcomings, immediately contact your supplier.

## STORAGE

If the damper is not installed immediately:

- Remove any wrapping.
- Protect damper from dust and contamination.
- Do not expose the damper to the effects of weather - store the damper in a dry place.
- Do not store the unit below -20 °C or above 50 °C.

**Please properly dispose of packaging material!**

## MAINTENANCE AND OPERATION

Constant volume dampers are designed with fully enclosed drive mechanism outside of the duct and as such do not require cleaning and regular maintenance.

However, activation mechanism should be inspected for proper operation on regular basis.

- Provide at least one annual check of the damper
- After each intervention, provide a systematic cleaning of dust
- Cleaning instruction: clean with a sponge, with water or a mild detergent
- Disinfection instruction: spray disinfectant (disinfectant may contain alcohol which is flammable, take precaution to avoid ignition)

It is not permitted to alter the dampers in any way nor perform any changes to their structure (except for the service procedures described in this manual) without the manufacturer's consent.  
Provide at least one annual check of the damper.

The functional test must be carried out in compliance with the basic maintenance principles of the European norms EN 13306, EN 15423 and EN15650.

## COMMISSIONING

- Carefully unpack RKP-P - be careful of sharp edges and do not use excessive force for unpacking
- Inspect the product - check the volume flow damper for damage
- Installation of the volume flow damper - according to the installation instructions ([page 4.](#))
- Before commissioning - check the product functions



## AIRFLOW REGULATION

---

Projektiranje, proizvodnja i održavanje opreme za klimatizaciju, ventilaciju i čiste prostore.  
Design, production and service of Ventilation, Air-Conditioning and Cleanroom equipment.

---

 Gradna 78A, 10430 Samobor, Croatia  
 +385 (0)1 33 62 513  
 [info@klimaoprema.com](mailto:info@klimaoprema.com)  
 [www.klimaoprema.com](http://www.klimaoprema.com)